

**Operating instructions
supplement
for
Electronic C3T0**

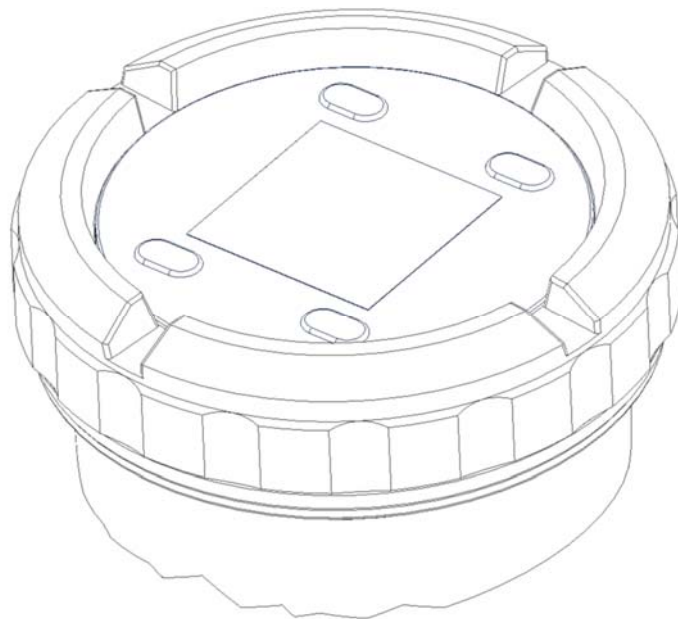

We don't accept warranty and liability claims neither upon this publication nor in case of improper treatment of the described products.

The document may contain technical inaccuracies and typographical errors. The content will be revised on a regular basis. These changes will be implemented in later versions. The described products can be improved and changed at any time without prior notice.

© **Copyright**

All rights reserved.

1. Contents

1. Contents	3
2. Note	4
2.1 Overview of the device functionality	4
3. Electrical connection	5
3.1 Pin assignment	5
3.2 Connection example outputs:	6
4. Operation and menu structure	7
4.1 General.....	7
4.2 Measuring mode.....	8
4.3 Menu Mode.....	11
5. Device configuration	12
5.1 Sequence of device parameterization.....	12
5.2 Language.....	12
5.3 Display.....	13
5.4 Measurement.....	15
5.5 Dosing function.....	23
5.6 Outputs	23
5.7 User service.....	36
5.8 Service / Factory service	37
5.9 Info.....	37
5.10 Device default settings.....	37
6. Dosing function	38
7. Disposal	42

Sold by:

Kobold Messring GmbH
Nordring 22-24
D-65719 Hofheim
Tel.: +49(0)6192-2990
Fax: +49(0)6192-23398
E-Mail: info.de@kobold.com
Internet: www.kobold.com

2. Note

Please read these operating instructions before unpacking and putting the unit into operation. Follow the instructions precisely as described herein.

The instruction manuals on our website www.kobold.com are always for currently manufactured version of our products. Due to technical changes, the instruction manuals available online may not always correspond to the product version you have purchased. If you need an instruction manual that corresponds to the purchased product version, you can request it from us free of charge by email (info.de@kobold.com) in PDF format, specifying the relevant invoice number and serial number. If you wish, the operating instructions can also be sent to you by post in paper form against an applicable postage fee.

The devices are only to be used, maintained and serviced by persons familiar with these operating instructions and in accordance with local regulations applying to Health & Safety and prevention of accidents.

2.1 Overview of the device functionality



Depending on the installed device firmware, the electronic C3T0 may have different functionalities. The functional extensions are shown in the following table.

Function extension	Available from firmware version
-	REV220905

The installed software version is displayed after starting the device below the manufacturer logo in the form REVxxxxxx for approx. 2 sec.

3. Electrical connection

3.1 Pin assignment

3.1.1 External connection with electrical connector M12x1 4-pin

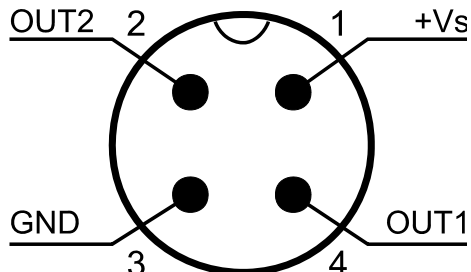

Note:

In principle, the cable can be shortened by the user on the transmitter side and connected to the transmitter again after appropriate assembly.



Attention!

A customer extension of the connection cable is not recommended because of the necessary continuous shielding and leads to malfunction of the device. The cable permanently connected to the sensor must not be disassembled.

3.2 Connection example outputs:

OUT2: analogue output 4-20 mA
 OUT1: analogue output 0-10 V

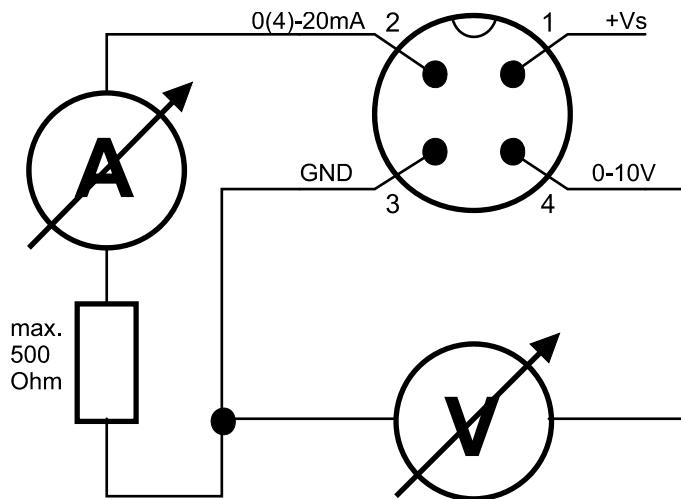

Configurable output functions:

Out 1	Out 2
analogue output 4-20 mA	analogue output 4-20 mA
analogue output 0-20 mA	analogue output 0-20 mA
analogue output 2-10 V	analogue output 2-10 V
analogue output 0-10 V	analogue output 0-10 V
alarm output	alarm output
pulse output	pulse output
frequency output	frequency output
communication mode KofiCom	
communication mode IO Link	
control input	
control input dosing function	dosing output

4. Operation and menu structure

4.1 General

4.1.1 Operation of the optical buttons

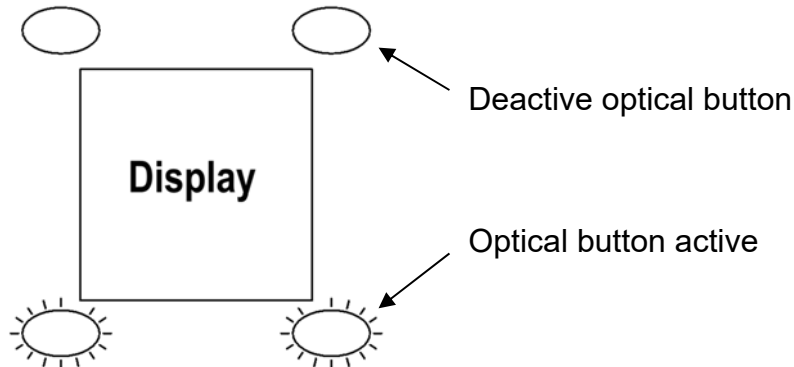

An optical button is located at each corner of the TFT display. The operability of the respective buttons is signaled by blue backlighting; therefore, non-backlit buttons are disabled and cannot be operated. To operate the keys, the finger must be placed on the key-dome and raised again. The orange background of the button symbols is briefly displayed in blue as visual feedback for a detected key press.



To avoid accidental operation in measuring mode, the operator must hold down the menu button for 3-5 seconds to activate the function. If the menu button is held down for more than 3 seconds, the blue backlighting will begin to flash to alert the user to release the button.

The operation of the optical buttons can also be done with gloves or other optically reflective objects. Suitable types of gloves are: cotton and textile gloves, light leather gloves, hygiene gloves made of latex and lightly rubberized work gloves. Black-coated work gloves of all kinds are not suitable. Light dirt on the surface usually does not interfere with the key function.

4.1.2 Function of the control buttons

The function of each control key can be recognized by the respective symbol displayed in the corners of the TFT display.

key symbol	designation	function	
		Measuring mode	menu mode
	menu mode	Activate menu mode hold 3-5 sec.	-
	info display	opens the info menu	-
	down	-	Scroll down menu / decrease numeric value when entering numeric value
	up	-	Menu scroll up / Increase the number

key symbol	designation	function	
		Measuring mode	menu mode
			value for numeric value input
	forward	-	Menu level lower / forward (last menu level: Save value)
	backward	-	Menu function: menu level higher / back (last step: exit menu)

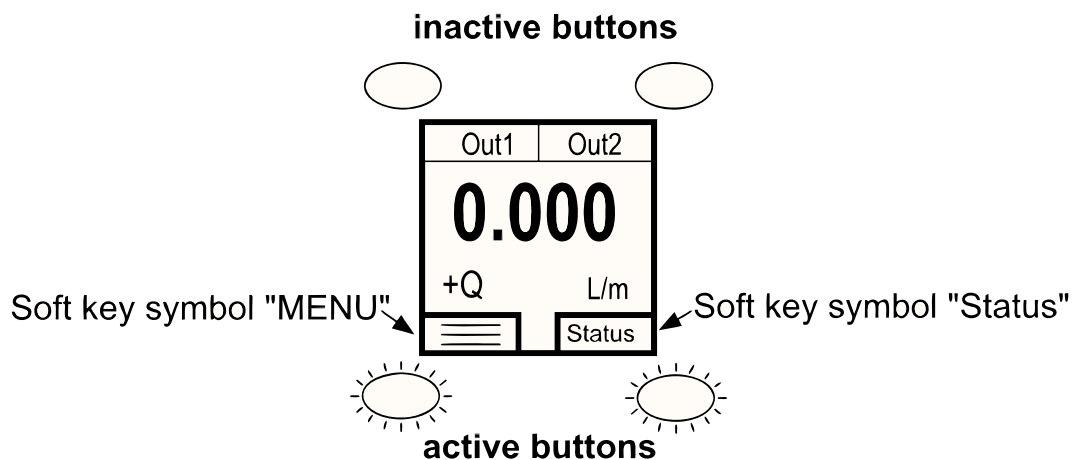

4.2 Measuring mode

After applying the supply voltage, the device starts in measuring mode. In this mode, the measured values of the respective measuring variables are continuously recorded; the current instantaneous flow values, temperature values and the volume counter readings are cyclically calculated and displayed according to the type of display.

In addition to the main display, the states and configuration of the outputs are shown in the display. If the corresponding output is configured as an alarm output, the status is also displayed with a green or red background color. If the background color is green, the set threshold value is exceeded; if it is red, the current value is still under threshold.

Measurement Mode Display Layout 'Single'

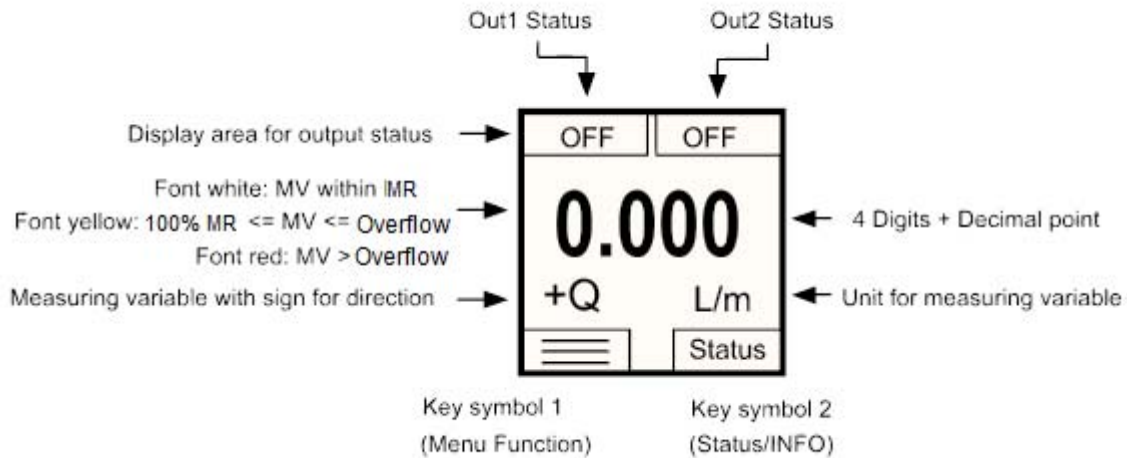

The measurement variables are represented by their corresponding symbols:

Menu entry	Mesuring variables Symbol	Description
Flow	Q	Flow rate
Volume	AC	Accumulated totalizer
Temperature	T	Medium temperature
Part volume	PT	Partial totalizer

The outputs and their status are shown on the display as follows:

Output function OUT1/2	Symbol	Representation
disable	OFF	
Analog output 4-20mA	4-20mA	
Analog output 0-20mA	0-20mA	
Analog output 0-10V	0-10V	
Analog output 2-10V	2-10V	
Alarm output PushPull	SW+-	Background grey/green
Alarm output PNP	SW+	Background grey/green
Alarm output NPN	SW-	Background grey/green
Pulse output	PLS	
Frequency output	FRQ	
Communication mode KofiCom (only OUT1)	KofiCom	Use only for factory service
Communication mode IO-Link (only OUT1)	IO-Link	
Control input	X CTL	"X" symbol of the selected measuring variable

The measured variables flow, temperature and volume counter can in principle be assigned to each output function. The assignment of the respective output is indicated by the display of the symbol of the measuring variable. The representation of the assignment is independent of the set display layout (single, dual).

Measurement Mode Display Layout 'Dual'

Out 1 configured as switching output pushpull and assigned to flow

Out 2 configured as analogue output 4-20 mA and assigned to temperature

Font white: MV within MR
 Font yellow: 100% MR <=MV <=OverFlow
 Font red: MV >OverFlow

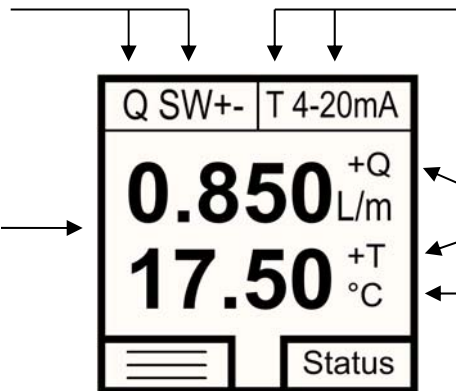

Measuring variables with sign for direction

Unit for measuring variable

Legend:
 MV - measured value
 MR - measuring range

Out 1 configured as pulse output and assigned to partial totalizer

Out 2 configured as analogue output 4-20 mA and assigned to temperature

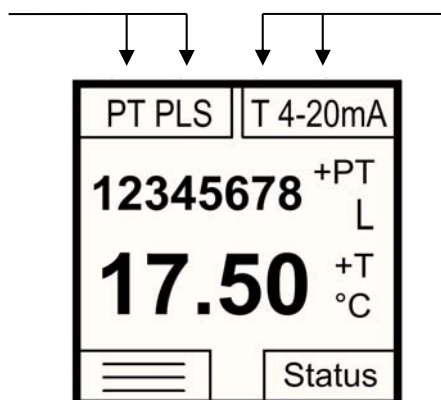

4.2.1 Display area of the flow meters

The number of digits displayed on the volume counter display (partial and total volumetric counters) is limited to max. 8 digits. The partial and total volumetric meters therefore have a smaller font size than the flow and temperature display. If the 8-digit display range of the meter is exceeded, this is indicated by the display of 8 minus characters (-----). In this case, the meter reading can no longer be read. The user now has the option of bringing the counter reading back into the display area by changing the volume counter unit.

4.3 Menu Mode

In menu mode, all device parameters can be set. The individual parameters are arranged in menu groups by function. While the menu mode is activated, the signal processing and the outputs are still active in the background. However, all display parameters and outputs are updated after exiting the menu mode or in the measuring mode.

Note: The menu mode will exit automatically after a certain time without using the buttons, if the parameter “Menu Timeout” is set not equal to “0”.

4.3.1 Parameter setting

4.3.1.1 List Selection



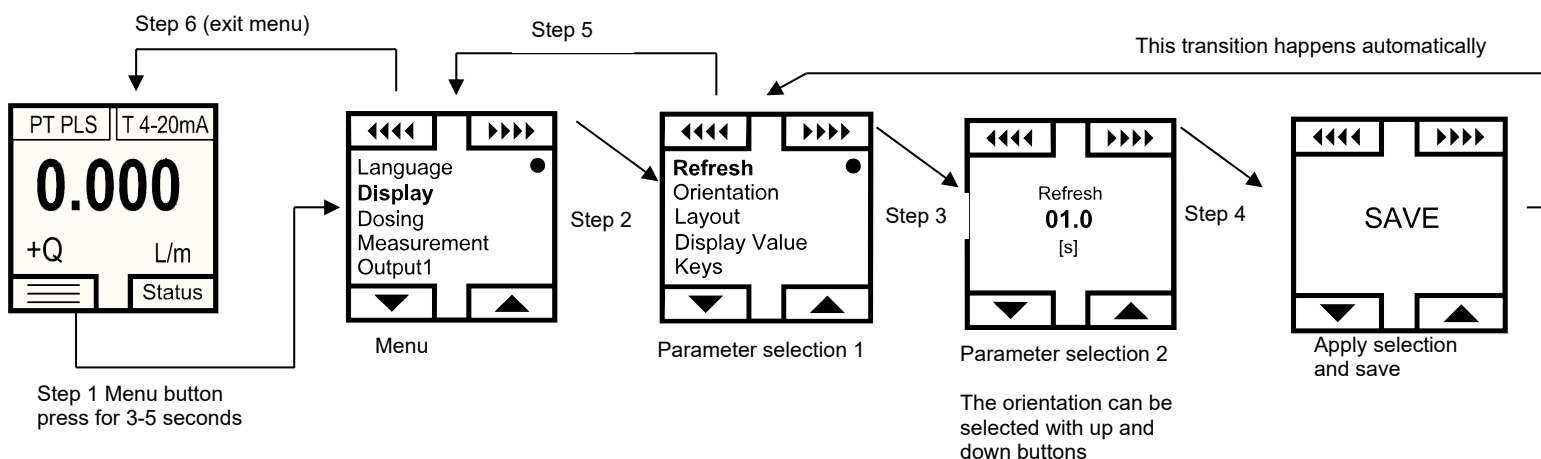

Parameters with predefined selection values are defined by means of list selection. The currently selected menu item is displayed in orange text. The selection can be moved with the keys, the key is used to accept the selection.

To activate the menu mode, press the button for 3-5 seconds. The parameters are divided into main groups and subgroups.

The buttons are used to select the main groups. In the main menu not all menu groups can be shown on the display at the same time, the list of individual menu items then scrolls up or down when the selection has reached the top or bottom. To choose the selection, the key is pressed and the device jumps to the corresponding submenu or parameter setting level. For selecting of predefined parameter values and are used. After changing the value of the parameter and confirming with the parameter is saved, and returns to the higher menu level. To return to the main menu or to exit the menu mode, press (repeatedly).



4.3.1.2 Numerical value input

When setting parameters with a numerical value, the assigned unit is always displayed below the input field in square brackets in the input function. The maximum size and the number of decimal places is fixed and cannot be changed. After calling the input function, first the left, outer digit is displayed in orange. This position can now be adjusted either with the keys   in the value from 0 to 9. By pressing the key , the entry point moves to the right and the next digit can be changed. By pressing the key , the editing point can be moved to the left again. If the editing point is on the far right, the set value is saved by pressing the key  again and switched to the higher-level menu function.

5. Device configuration

5.1 Sequence of device parameterization

The measurement device is pre-configured in factory. Changing the parameters "Measuring range" and "Sensor constant" or "K factor" is therefore not permitted. The adjustment of these parameters is only possible on the part of Kobold-factory. In the event of subsequent changes to volume or throughput units, the dependent parameters are converted and adjusted accordingly. However, the limit parameters of the switching outputs must always be checked and adjusted manually when adjusting volume or throughput units - these are not automatically converted.

An accidental change of the parameterization can be revised by the function "Reset factory setting" in the menu Userservice / Reset.

5.2 Language

In this menu item the menu language can be changed in English, German, French or Spanish (standard: English).

Parameter table language

Sublevel	parameter level	Sub-parameter level 1	Sub-parameter level 2	Sub-parameter level 3	Description	Value range / value list	Standard value LPM version	Standard value GPM version
English					Selects English as the menu language		English	
Deutsch					Selects German as the menu language			
Francais					Selects French as the menu language			
Espanol					Selects Spanish as the menu language			

5.3 Display

5.3.1 Refresh

Parameter "Refresh" defines the time interval within which the measuring variables are displayed. The "Refreshrate" can be increased in steps of 0.5 sec. to 10 sec. An increase in the refresh rate time causes an increased "filtering" of the display value.

5.3.2 Orientation

With the menu item "Orientation" the display can be rotated either clockwise or counterclockwise in 90 ° increments. As the display rotates, both the display contents and the function of the 4 control buttons are turned.

5.3.3 Layout

This parameter can be used to configure the display to either show one measurement variable or two measurement variables.

5.3.4 Display value

With the aid of this parameter, the measurement variables provided by the transmitter can be displayed. Depending on the 'Layout' display, either one or two measuring variables can be displayed.

5.3.5 Keys HOTKEYS

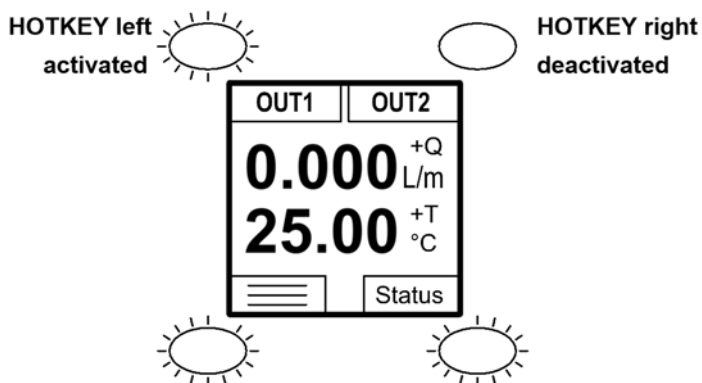

Two independent user keys are available, which can be individually assigned with different display functions. The 2 user keys are available in measurement mode top right and left. If the buttons are activated, they are backlit in blue and the programmed function can be executed by touching.

The following functions are available:

reading	MIN/MAX / Reset	Value display / Reset
flow	Yes / Yes	Yes / No
Temperature	Yes / Yes	Yes / No
Partial quantity counter	Not available	Yes / Yes
Totalizer	Not available	Yes / No

The called hotkey function remains permanently activated and can only be left by pressing the key . A direct reset function is available for the MIN / MAX measured value function and the partial quantity counter.

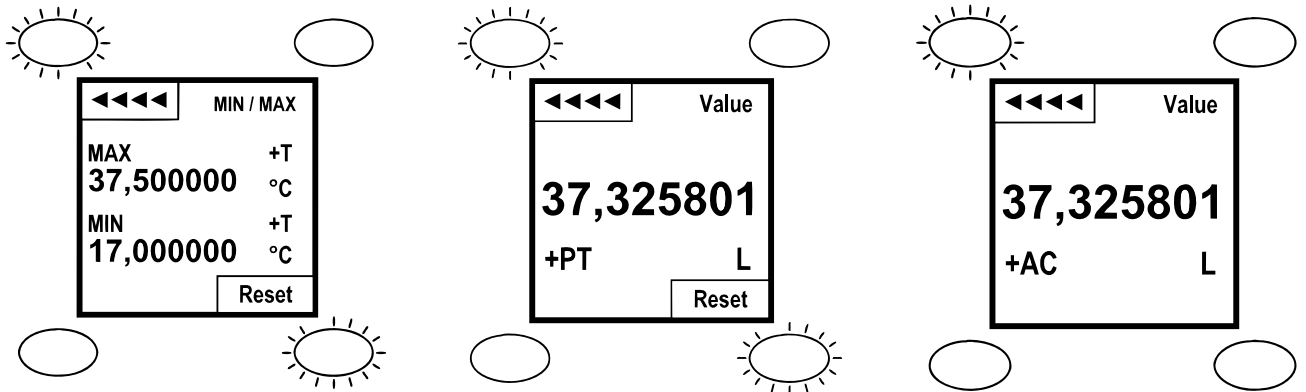

5.3.6 Menu Timeout

The menu timeout time defines the time after which the menu function is automatically exited without pressing a key. In the setting "0 s" this function is deactivated and the menu function can only be left by hand by pressing the back key several times.

Parameter table Display

Sublevel	Parameter level	Sub-parameter level 1	Sub-parameter level 2	Sub-parameter level 3	Description	Value range/ value list	Default value LPM version	Default value GPM version	
Refresh	<i>value input</i>				Sets the display refresh rate	<i>0.5-10 sec</i>	<i>0.5 sec</i>		
Orientation	<i>rotate CW</i>				Rotates the display 90 ° clockwise		<i>Landscape</i>		
	<i>rotate CCW</i>				Rotates the display 90 ° counterclockwise				
Layout	Single				Shows a measured value in the display area			<i>Double</i>	
	Double				Shows two measured value in the display area				
display value	Upper display	<i>list selection</i>			Sets the reading for the upper display	<i>Flow, volume, temperature, part volume</i>	<i>Flow</i>		
	Lower display				Sets the reading for the lower display		<i>Temperature</i>		
Keys	Hotkeys	left	<i>Flow</i>	<i>List selection</i>	Sets the reading and function for the left hotkey	<i>Off, Value, Min / Max</i>	<i>Off</i>		
			<i>Volume</i>						
			<i>Temperature</i>						
			<i>Part volume</i>						
	right	<i>Flow</i>	<i>List selection</i>	Sets the reading and function for the right hotkey	<i>Off, Value, Min / Max</i>				
		<i>Volume</i>							
<i>Temperature</i>									
<i>Part volume</i>									
sensitivity	<i>list selection</i>			Sets the sensitivity for the optical buttons	<i>Low</i>	<i>Low</i>			
Menu Timeout	<i>value input</i>				Defines the time after which the setting menu is automatically exited without pressing a key (0 = deactivated)	<i>0.5 to 60 s</i>	<i>15 s</i>		

5.4 Measurement

The menu "Measurement" lists the measurement variables, which the sensor provides.

- Flow
- Volume (total volume counter)
- Temperature
- Part volume

Each measurement variable is still divided into its own submenu. In the submenu, all parameters relating to the respective measuring variables can be adjusted.

5.4.1 Flow

5.4.1.1 Unit

The displayed unit for the flow measurement can be selected from various predefined standard units. It is also possible to define a user-defined unit ("user"), here the "user unit" must be in LPM (liters / min.) be programmed:

e.g. Unit User = 100 LPM, if Q = 500 LPM then the display shows 5 users.

5.4.1.2 Filter function

The measured value filter filters the display value and most electrical output signals (analog outputs / frequency outputs / switching outputs).

A separately adjustable filter is available for each measured value (flow and temperature). In the factory setting, the standard filter with low filtering and active step detector is activated. Volume counters and pulse outputs are generally not filtered.

There are 3 different filter types available, so that a suitable filter functionality is available for as many applications as possible. The time base of the filter function is approx. 20 ms.

Filter type	Filter factor [n]	Step detector	Description
Standard	1 - 250	Yes	Rolling filter type, the size of the filter factor determines the number of temporarily stored and used averaging values. $MV_{AVG} = \frac{MV_0 + MV_{-1} + \dots + MV_{-n}}{n}$
IIR		No	With this filter type, depending on the filter factor, part of the last measured value average is added to the current average value. The filter corresponds to a digital low-pass filter of the 1st order with an infinite step response. The filter effect achieved is not linear to the parameter filter factor. A high filter effect is only achieved with filter values > 200. $MV_{AVG} = b * MV_0 + (1 - b) * MV_{AVG-1}$ with $b = \frac{251 - filter\ factor}{250}$
Exp. smoothing		No	The filter type works on the principle of exponential smoothing. The step response has an exponential course. The filter factor is proportional to the response time t_{90} of the step response. This enables the greatest filter effect to be achieved. $t_{90} \sim filter\ factor * 75ms$ $MV_{AVG} = \frac{MV_{AVG-1} * (n - 1) + MV_0}{n}$
with: MV_{AVG} = filtered measured value, MV_{AVG-1} = last filtered measured value, MV_0 = current measured value MV_{0-1} = last measured value			

Application areas of the filter types

Standard	<p>Standard filter with step detector with fast response time with real changes in measured values. This filter type has a max. time lag of filter factor * 20 ms</p> <p>This filter smoothes slight to medium fluctuations in measurement values without the disadvantage of increasing the response time in flow monitoring applications.</p>
IIR	<p>Simple digital filter with lag, no step detector</p> <p>This filter can be used for slight to medium pulsating fluctuations in measured values. With strong filtering, there is a correspondingly long lag of the filtered measured value in case of real measured value changes. Not suitable for flow monitoring applications with a large filter factor.</p>
Exp. Smoothing	<p>Simple smoothing filter with lag, no step detector</p> <p>This filter can be used for strong pulsating fluctuations in measured values. With strong filtering, there is a long lag of the filtered measured value with real measured value changes.</p> <p>The lag can be determined via the filter factor to: $t_{90} \sim \text{filter factor} * 75\text{ms}$</p> <p>Not suitable for flow monitoring applications with a large filter factor.</p>

Step detector (only available with standard filter)

The step detector integrated in the standard filter can detect the tendency of a real change in the measured value and temporarily bridge the filter function after detection of a step in the measured value in order to minimize the step response time. A step (sudden change) in the measured value can be detected both with increasing and with falling measured value. The step detector is set by the step threshold (*JD threshold*) and an interference suppression factor (*JD-ConfFactor*). The behavior at the beginning of the measuring range can be made "interference suppressed" with the parameter *0-ConfFactor*.

JD Threshold	The value of the step threshold is normalized according to the span of the measuring range, the default value 0.1 means 10% of the full scale value.
JD ConfFactor	Defines the factor by which the step threshold must be exceeded in succession without interruption before the step detector actually becomes active. If the end value of the interference suppression counter is not reached, it will be reset. However, if the final value of the counter is reached, the step detector is active and all filter buffers are overwritten with the current measured value.

0-ConfFactor

If the measured values are at the start of the measuring range, below which the measured values are set to 0, the zero measured value suppression function may become active. The parameter *0-ConfFactor* defines a counter value, how often the measurement range start value must fall short of in succession and without interruption before the measurement value is actually set to "0". This function serves to stabilize the measured value in the area of the start of the measuring range. Like the step detector, this function works in both directions, i. e. from measuring range => 0 and from 0 => measuring range.

Notes for applications with pulsating flows:

If flow pumps generate pulsating flow (e.g. peristaltic pumps or diaphragm pumps), the following instructions must be observed:

- The pulsation flow peaks must always be within the measuring range of the device
- If possible, install a pulsation damper
- The pulsation frequency of the pump should not be close to the 50 Hz frequency or its divider (25 Hz, 12.5 Hz, 6.25 Hz etc.), otherwise cyclical measurement fluctuations may occur.
- The measured value display (and the electrical analog and frequency outputs) can be most effectively dampened using the filter function "exp. Smoothing"

5.4.1.3 Separation

The parameter Separation sets the flow rate below which the measured value is set to "0". If this function is active, the flow value "0" is shown in blue colour in the display. If the parameter value is set smaller than the start of the measuring range (see technical data), the display value and all signal outputs assigned to it remain at "0" as long as the measured value does not exceed the start of the measuring range.

5.4.1.4 Simulation mode

See section 5.4.5

5.4.2 Volume

5.4.2.1 Counter type

Absolute:

Regardless of the flow direction, the calculated partial volume is added to the counters.

Bidirectional:

Depending on the flow direction, the calculated partial volume is added or subtracted to the counters. If the measured flow value is negative, the volume value goes down from measurement to measurement (possibly into the negative range).

Volume measurement by different totalizer types

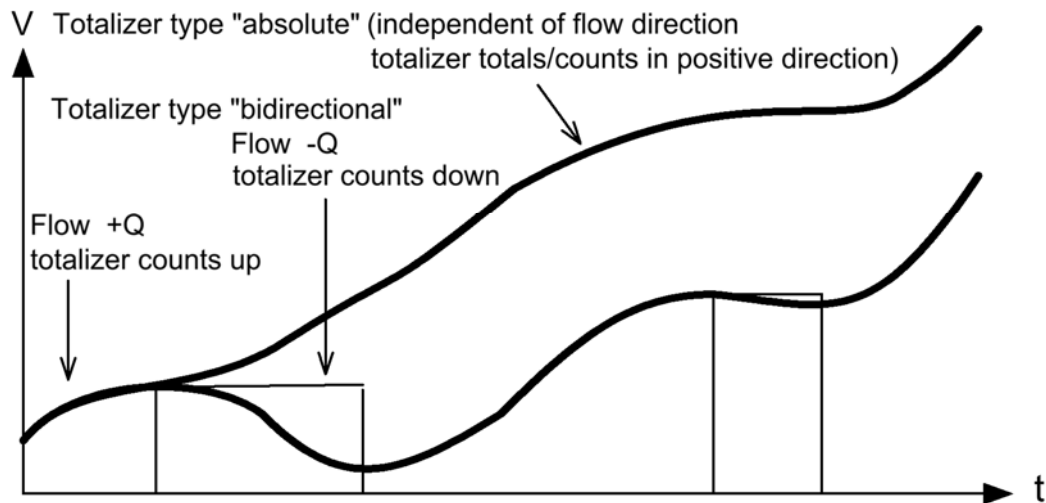

5.4.2.2 Unit of the total volume counter

The parameter "Unit" determines the volume unit of the total volume counter. The listed volume units are available. When changing the volume unit, the current counter reading is converted to the new volume unit.

It is also possible to define a user-specific unit "User". Here the "user unit" must be programmed in liters: e.g. unit "User" = 100 L, if the internal volume value reaches 500 L, then 5 "User" is shown on the display.

5.4.3 Temperature

5.4.3.1 Temperature Unit

The displayed unit for the temperature measurement can be selected from various default units. It is also possible to define a user-defined unit ("user"), in which case the "user unit" must be programmed in °C.

e. g. Unit "user" = 50 °C, if $T = 50$ °C then the display shows 1 user.

5.4.3.2 Simulation function

See section 5.4.5

5.4.4 Part Volume

5.4.4.1 Counter type

Absolute:

Regardless of the flow direction, the calculated partial volume is added to the counters.

Bidirectional:

Depending on the flow direction, the calculated partial volume is added or subtracted to the counters. If the measured flow value is negative, the volume value goes down from measurement to measurement (possibly into the negative range).

5.4.4.2 Unit of the part volume counter

The parameter "unit" defines the volume unit of all volume meters. The listed volume units are available. When changing the volume unit, the current counter readings are converted to the new volume unit.

It is also possible to define a user-specific unit "User". Here the "user unit" must be programmed in liters: e.g. unit "User" = 100 L, if the internal volume value reaches 500 L, then 5 "User" is shown on the display.

5.4.4.3 Memory reset

In this menu, the part quantity counter can be reset.

5.4.4.4 Simulation function

See section 5.4.5

5.4.5 Simulation function

With the simulation function, all available measured values can be simulated independently of each other for a limited time. The simulated measured values have full effect on the displays and outputs.

Each simulation started is automatically stopped after the time set in the "Sim Auto Stop Time" (user service) parameter (1 to 30 min) or after the programmed intervals have expired.

The following measured values can be simulated:

Volume flow, temperature and part quantity counter

The simulation starts as soon as the simulation is activated and the setting menu is exited. The simulation is interrupted or stopped, if the setting menu is called up. There are 3 different simulation types available for each purpose:

a.) „Triangle“ mode

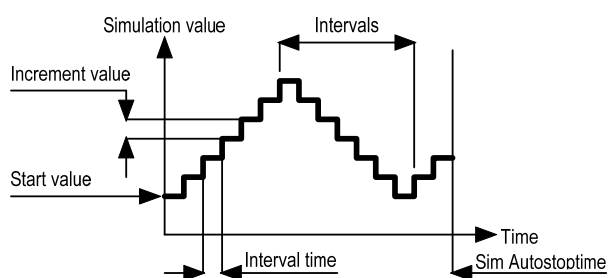

In "Triangle" mode, the simulation value increases continuously in the increment of the parameter "Increment value" and in the interval "Interval time" with the "Start value". After the amount of the parameter "intervals", the simulation value decreases again in the same way, in order to increase again. This

process is repeated continuously until the set time "Sim Auto Stop Time" has expired and the simulation ends.

b.) "Monotonic" mode

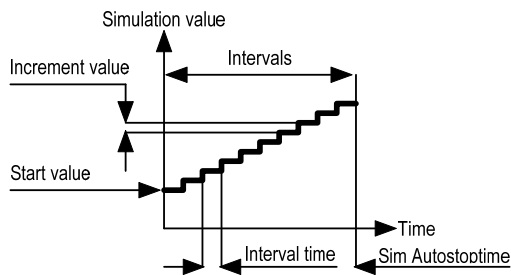

In "Monotonic" mode, the simulation value increases continuously in the step size of the parameter "Increment value" and in the interval "Interval time" with the "Start value". After the amount of "Intervals" or the expiration of "Sim Auto Stop Time", the simulation ends.

c.) "Static" mode

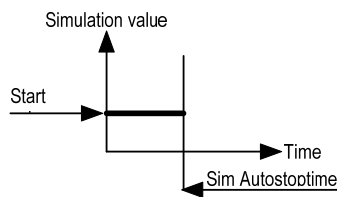

In the "Static" mode, a constant value is output for the measured values flow and temperature. The simulation ends after the set simulation time.

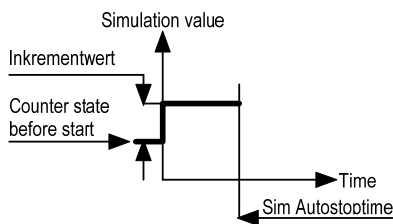

In the "static" simulation for the part quantity counter, the counter is only changed once by the set "increment value" after the start.

When simulating the subset counter, note that in triangle mode, the submenu counter must be in bidirectional mode to achieve the expected effect.

Parameter table **Measuring**

Sublevel	Parameter level	Subparameter level 1	Subparameter level 2	Subparameter level 3	Description	Value range/ value list	Default value LPM version	Default value GPM version
Flow	Unit	List selection			Sets the flow unit	L/m, L/h, m3/h, galUS/m, galUS/h, galUK/m, galUK/h, L/s, mL/s, User	L/m	gals/m
	Filter	Type	List selection		See description	Default / IIR / exp. smoothing	standard	
		Filter factor	Value input			1-250	25	
		JD threshold				0.05 – 1.00 [xFs]	0.1	
		JD-ConfFactor				1-25	1	
		0-ConfFactor				1-25	1	
	separation	value input			Sets the value for the low flow cutoff	$0 \leq \text{Value} \leq$ Range start	Range start	
Simulation mode	See table <i>Simulation mode</i>							
Volume	Counter Type	absolute/ bidirectional			Sets the counting mode		absolute	
	Unit	List selection			Sets the volume unit	ml, L, m3, galUS, galUK, User	L	L
Temperature	Unit	List selection			Sets the temperature unit	°C, °F, User	°C	°C
	Filter	Type	List selection		See description	Default / IIR / exp. smoothing	standard	
		Filter factor	Value input			1-250	1	
		JD threshold				0.05 – 1.00 [xFs]	0.1	
		JD-ConfFactor				1-25	1	
		0-ConfFactor				1-25	1	
	Simulations-modus	See table <i>Simulation mode</i>						
Part volume	Counter Type	absolute/ bidirectional			Sets the counting mode		absolute	
	Unit	List selection			Sets the volume unit	ml, L, m3, galUS, galUK, User	L	galUs
	memory reset	Yes/No			Sets the counter value to "0"			
	Simulation mode	See table <i>Simulation mode</i>						

5.5 Dosing function

see section 6

5.6 Outputs

The electronic C3T0 provides a total of 2 outputs that are freely configurable. The configuration of the outputs (output 1 and output 2) is done via a wizard function. The wizard function guides the user step by step through all necessary settings.

Steps:

- Select output
- Selection of the source or the measurement variable to be output (Flow, Volume, Temperature, Part volume)
- Selection of an output type (4-20 mA, 0-20 mA, 0-10 V, 2-10 V, alarm, pulse, frequency output, IO-Link, control input)
- Setting the output (scaling, thresholds)
- Save the configuration

The different output types are optimized for different types of applications. The following table contains the application recommendations for the different output types. If the outputs are not used according to the recommendations, measurement deviations can occur and the desired functionality is not achieved.

Application	Output type			
	Analog output (all variants)	Frequency output	Pulse output	Alarm output
Telemetry device	✓	✓		
Limit monitoring				✓
Window monitoring				✓
External dosage			✓	
External volumetric count			✓	

Application table output types

5.6.1 Alarm output

The alarm outputs can be parameterized with a limit value function or a window function.

5.6.1.1 Function

The parameter "*Function*" defines the basic function. Limit value function and window function are available.

Limit value function: The switching output is **active** if the current flow rate value is above the switching threshold. It remains **active** until the measured value has fallen below the switching threshold minus the hysteresis.

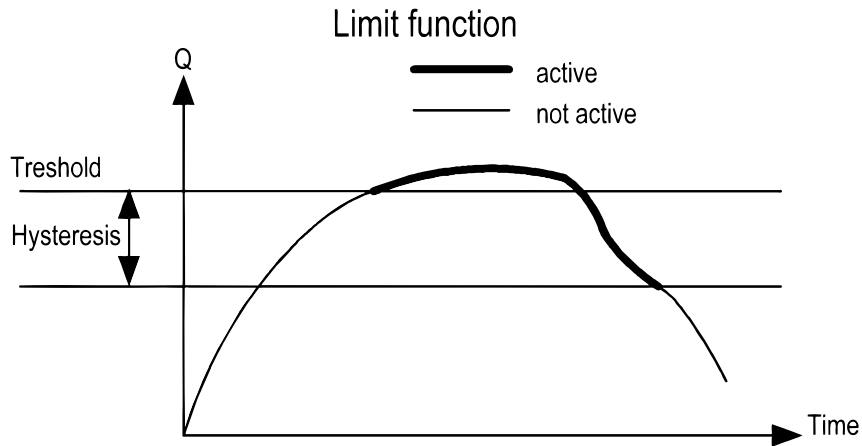

Window function: The switching output is **active** if the current flow measured value is outside a window, which is formed by the "switching threshold" and the "lower threshold". The monitored window decreases in each case by the amount of the "hysteresis". If the switching output is to be **active** within the window, the parameter "switching function" must be changed from N/O to N/C.

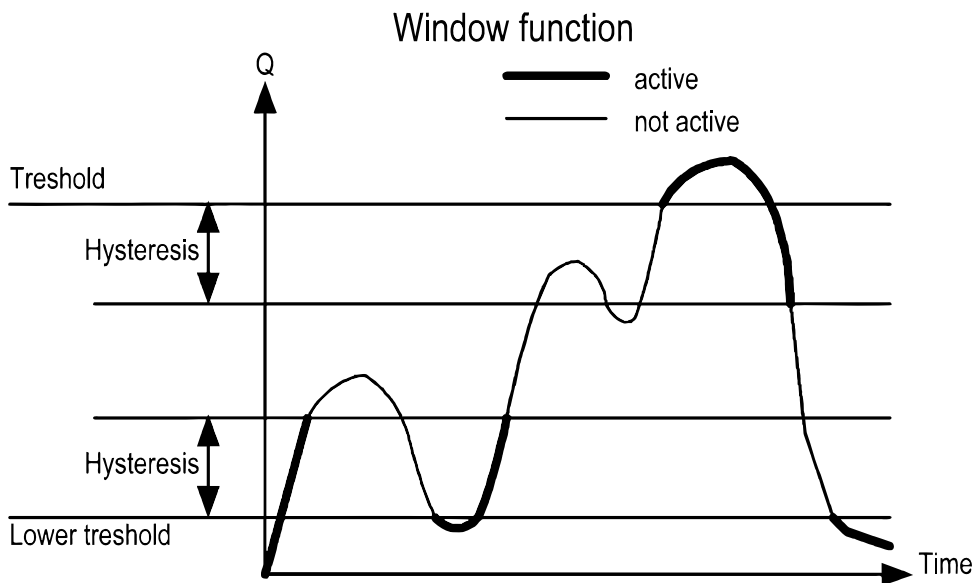

5.6.1.2 Output type

The parameter "Output type" defines the function of the transistor output. NPN, PNP or PP (push-pull) output types are available. The push-pull type combines NPN and PNP and is therefore the best choice for most circuits. All outputs are short circuit and overload protected.

5.6.1.3 Switching function

The "switching function" defines the mode of operation of the outputs. In the default setting "normally open", the output becomes active (switched) when the measured value exceeds the switching threshold. This feature is also referred to as N.O. In the "Normally closed" setting, the output below the switching threshold is already active and is deactivated when the measured value exceeds the switching threshold. This function is also referred to as N.C.

5.6.1.4 Threshold

Threshold for limit value function and upper window point for window function.

5.6.1.5 Lower threshold

The "lower threshold" defines the lower limit when using the window function. When using the limit value function, this parameter remains ineffective.

The switching thresholds can be set both positive and negative.

5.6.1.6 Hysteresis

The appropriate setting of the "hysteresis" parameter ensures that the switching outputs do not switch on and off continuously when the current measured value fluctuates around the switching threshold. The hysteresis value should therefore always be greater than the real measured value fluctuations. As a result, a targeted suppression can be achieved.

5.6.1.7 Filter factor (delay)

Further suppression of the switching outputs of fluctuating measuring signals can be achieved by setting the parameter "Filter factor". If this parameter is selected greater than 0, the switching of the output will be delayed accordingly. The "Supp direction" parameter determines whether the deceleration is to be effective when the switching threshold is exceeded or not reached (alternatively in both directions). "High" means that the delay is active when the measured value exceeds the switching threshold, "Down" means corresponding effect when the switching threshold is undershot.

The measured value must stay continuously below or above the switching threshold with the count of [SUPPRESSIONFACTOR] before the switching output will be activated. With this function sporadic limit value overruns can be safely suppressed.

According to the value of the parameter "filter factor", the response time of the output generally increases.

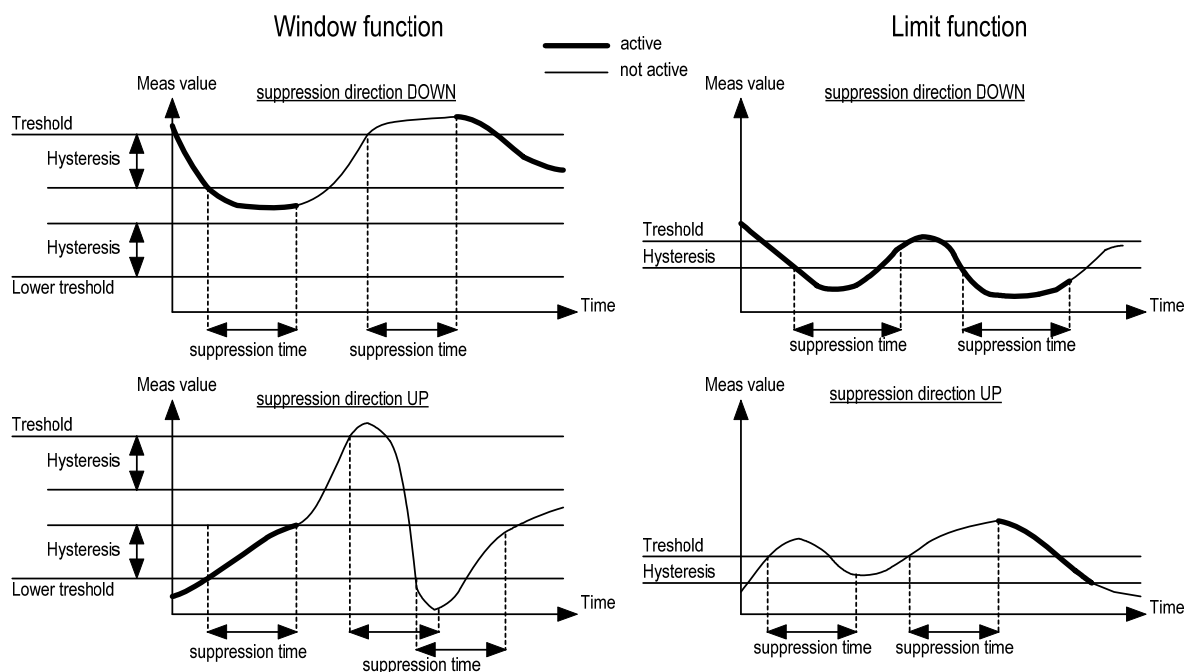

Examples of the effect of the switching delay for window and limit function

5.6.2 Analogue outputs



Note: The end values of the analogue outputs (20 mA/10 V) are factory set to full scale of the respective measuring range. If this setting is changed manually, this parameter must be verified and, if necessary, adjusted each time the source for the respective output (flow rate or temperature) is changed.

5.6.2.1 Current output 0(4)-20 mA

The current output gives a measured variable (flow or temperature) in scaled form as a 0 (4) -20 mA current signal.

The current output is scaled via the "Value 20 mA "and" Value 4 mA "(with current output 0-20 mA "Value 0 mA"). By default, the "Value 20 mA" parameter is set to the value for the end of the measuring range, but can be parameterized as desired within the measuring range, but always bigger than the measuring range start value. The parameters "Value 4 mA" / "Value 0 mA" define the measured values for the starting current value, which may also be set freely in the measuring range.

Note 1: If the value is set smaller than the end of the measuring range, the accuracy of the output voltage value is reduced.

Note 2: The burden on the current output must not exceed 500 Ω .

5.6.2.2 Voltage output 0-10 V / 2-10 V

The voltage output outputs a measurement variable (flow or temperature) in scaled form as a 0-10 V / 2-10 V voltage signal.

The scaling of the voltage output is done via the parameter "Value 10 V "and "Value 0 V". By default, the "Value 10 V" parameter is set to the value for the end of the measuring range, but can be parameterized as desired within the measuring range, but must always be bigger than the measuring range start value.

The parameters "Value 0 V" and "Value 2 V" define the measured values for the start voltage value, which may also be freely set in the measuring range.

Note 1: If the value is set smaller than the end of the measuring range, the resolution and accuracy of the output voltage value are reduced.

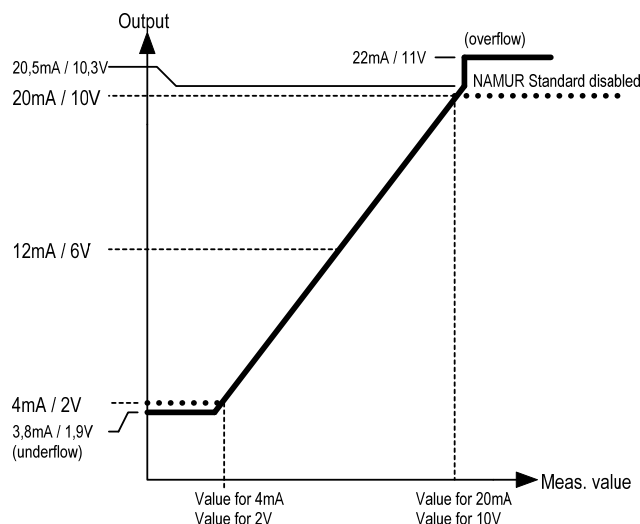

Output behavior 4-20 mA and 2-10 V

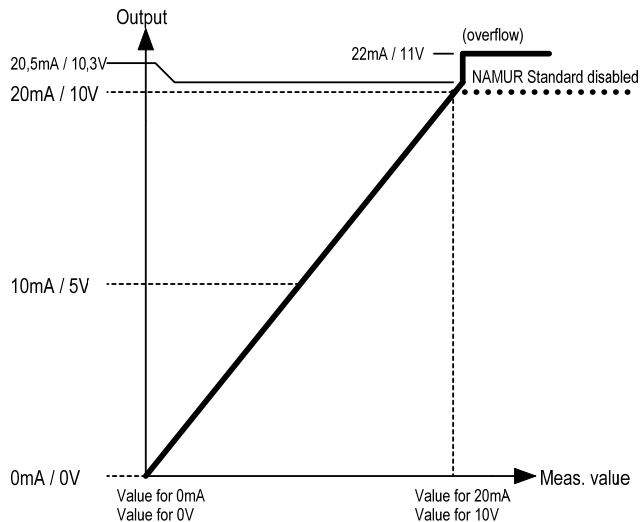

Output behaviour 0-20 mA and 0-10 V

5.6.2.3 Activation of behaviour according to NAMUR recommendation NE43

For all analogue outputs (current and voltage), the output behaviour can be activated according to NAMUR recommendation NE43. When the function is activated, e.g. the linear output of the 4 to 20 mA signals to 3.8 to 20.5 mA. Above 20.5 mA, the current value jumps to approx. 22 mA to signalise a measuring range overshoot. Current output values between 3.8 and 4.0 mA indicate that the measuring range is undershot. The output of approximately 3.6 mA signals a device or process fault (e.g., empty tube signalling).

5.6.3 Pulse output

The electronic C3T0 provides a scalable pulse output. When the pulse output is activated, the cyclically incoming volume is available as a pulse train at the output. The pulse width of the pulse output is constant and can be set in a range of 1 ms up to 20 s. The pulse output is updated in a cycle of 20 ms. At the beginning of each update, it is determined how much volume has been accumulated during the previous update period. According to this amount and the set pulse volume, the corresponding amount of pulses is available as a pulse train at the output.



The pulse signal is not suitable for determining the volume flow with an external frequency measurement.



The reaction time of the pulse output is directly dependent on the flow parameter "separation" (cutoff). The shortest reaction time is reached if this parameter is set to the value "0.0" (factory setting: start of measuring range).

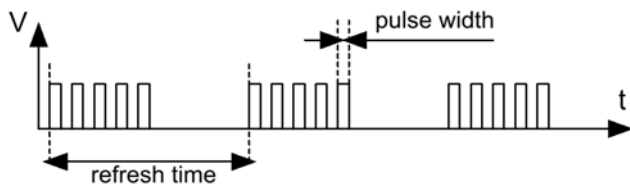

The electrical output type of the pulse output is push-pull, therefore HIGH and LOW are actively switched through at the output.

Pulse output function with different totalizer types

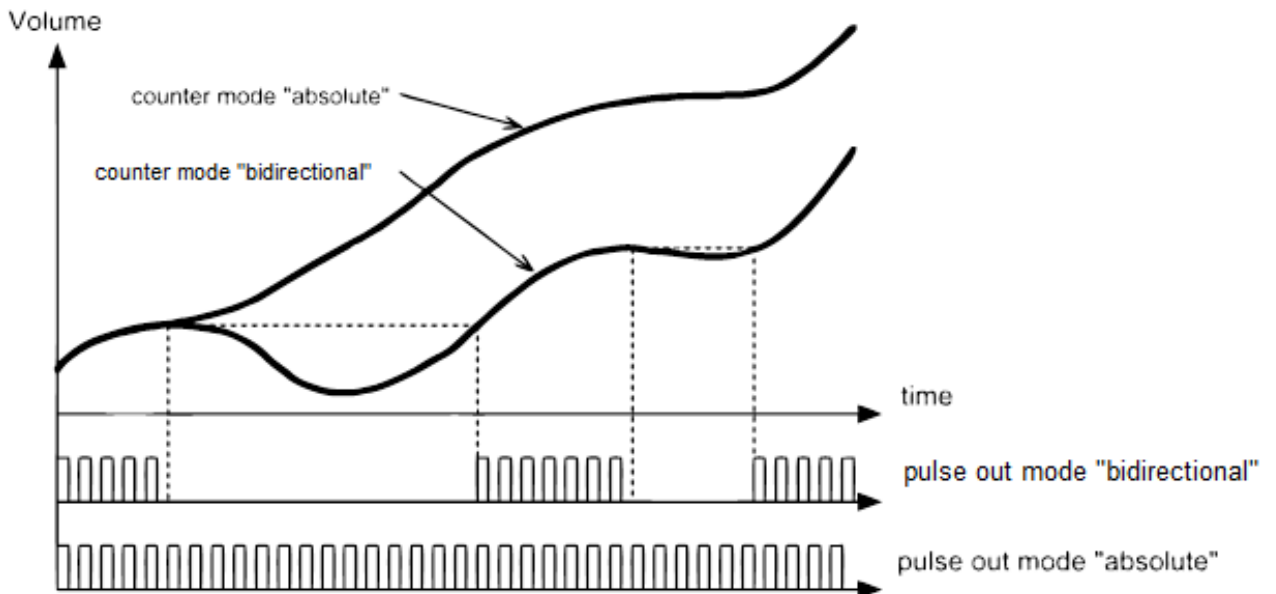

Behavior on OVERFLOW:

If the volumetric flow measurement is in the OVERFLOW range, the pulse output is switched off and a constant HIGH level is applied to the output.

Generation of the output pulse train:

The pulse volume (pulse value volume per output pulse) can be set freely within wide ranges. Together with the adjustable pulse width and the measuring range of the device there is a limited range in which the pulse output is instantaneous.

This is the case if the following condition is met:

$$\frac{\text{MRE-Measurement Range End [L/min]} * \text{pulse width [ms]}}{\text{pulse volume [L]}} \leq 22500$$

or

$$\text{Pulse volume [L]} \geq \frac{\text{MRE-Measurement Range End [L/min]} * \text{pulse width [ms]}}{22500}$$

If the condition is not met, there may be a time lag of the pulse output. This is particularly undesirable if dosing tasks are to be performed with the pulse signal.

The following table shows the exemplary combinations of pulse volume and pulse width for the different measuring ranges, in which the above limiting condition is fulfilled.

Measuring range [LPM]	pulse width [ms]	min. pulse volume [L]	max. pulse rate [pulse/L]
350	20	0.31111	3.21
	10	0.15556	6.43
	5	0.7778	12.86
	1	0.01556	64.29
100	20	0.08889	11.25
	10	0.04444	22.50
	5	0.02222	45.00
	1	0.00444	225.00
50	20	0.04444	22.50
	10	0.02222	45.00
	5	0.01111	90.00
	1	0.00222	450.00
25	20	0.02222	45.00
	10	0.01111	90.00
	5	0.00556	180.00
	1	0.00111	900.00
10	20	0.00889	112.50
	10	0.00444	225.00
	5	0.00222	450.00
	1	0.00044	2250.00
03	20	0.0026	375
	10	0.0013	750
	5	0.0006	1500
	1	0.0001	7500
01	20	0.00089	1125.00
	10	0.00044	2250.00
	5	0.00022	4500.00
	1	0.00004	22500.00

The pulse output only takes place in measuring mode; while the menu mode is active no pulses are given. The pulses accumulated in the menu mode are output as soon as the measuring mode is active again. Depending on the situation, this can also lead to a longer pulse lag.

5.6.3.1 Pulse volume

The parameter "Pulse volume" is defined as volume quantity for the output of a pulse; the unit is corresponding to [volume quantity / pulse]. The likewise common pulse rate [pulse / volume unit] corresponds to the reciprocal of the pulse volume. Example: Desired pulse rate at the output 10 pulses / liter => pulse volume = 1 / pulse rate = 1/10 L = 0.1 L

5.6.3.2 Volume unit

The volume unit to be set is the input unit for the "Pulse volume" parameter. The definition of a user-defined unit ("user") is also possible and can be programmed in "liters".

Example:

Unit "user" = 10 [L], pulse volume = 2 [user]

The total pulse volume would be $2 * 10 = 20$ [L]. After 20 liters, a pulse is output.

5.6.3.1 Pulse width

The pulse width of the pulse output is flexibly adjustable from 1 to 20,000 ms.

5.6.4 Frequency output

The electronic C3T0 provides a scalable frequency output. When this output is activated, the measurement variable (flow or temperature) associated with the frequency output is output proportionally as a frequency with a 1: 1 pulse / pause duration. The output frequency at the end of the measuring range can be set (parameter "maximum frequency"). With the two parameters "Value for 0 Hz" and "Value for max Hz", the frequency output in the measuring range can be freely scaled.

Behavior on OVERFLOW:

If the measured value is in the overflow range, a constant frequency is output.

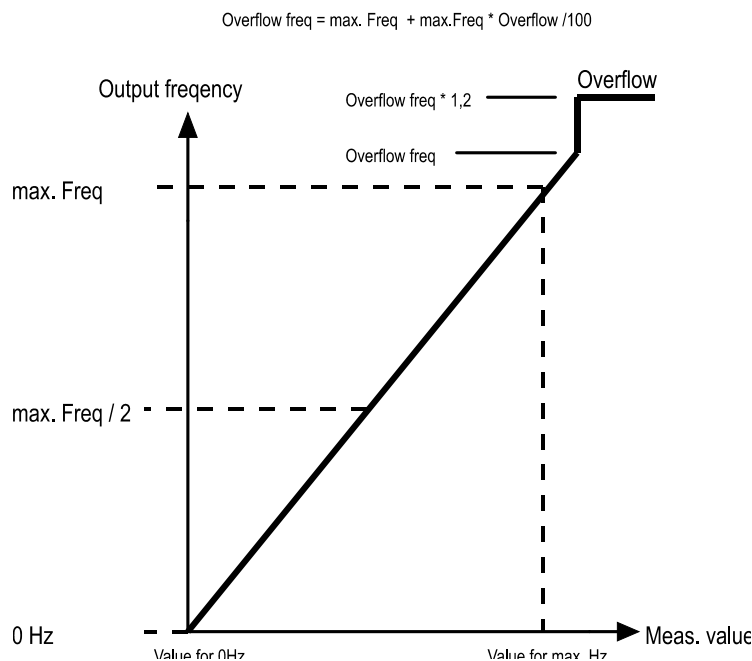

Output behavior Frequency output



Note: The end values of the frequency outputs are factory set to full scale of the respective measuring range. If this setting is changed manually, this parameter must be verified and, if necessary, adjusted each time the source for the respective output (flow rate or temperature) is changed.

5.6.5 Control input

Output 1 can be configured as a control input. This can reset the MIN / MAX memory or the partial quantity counter depending on the assigned measurement variable.

Function	Measurement variable	Control pulse duration
MIN/MAX Reset	Flow, temperature	$0.5s < t_{high} < 4s$
Part volume counter reset	Part volume counter	$0.5s < t_{high} < 4s$

Parameter table **Output 1/2 – Flow**

Sub-parameter level 1	Sub-parameter level 2	Sub-parameter level 3	Description	Value range / value list	Standard value LPM version	Standard value GPM version
<i>disabled</i>			<i>Output deactivated</i>		<i>IO-Link</i>	
Alarm output	Function	<i>List selection</i>	Sets the basic function	<i>Limit function / window function</i>	<i>Limit function</i>	
	Output		Sets the electr. Output	<i>NPN/PNP/PP</i>	<i>NPN</i>	
	switching function		Set the log. switching function	<i>NO/NC</i>	<i>NO</i>	
	threshold		Sets the switching threshold	$MB\ start \leq value \leq Full\ scale$	<i>1</i>	
	lower threshold		Sets the lower threshold for window function	$Value\ threshold \leq value \leq MB\ start$	<i>1</i>	
	hysteresis		Defines the switching hysteresis	$0 \leq value \leq (MB\ end - MB\ start)$	<i>1</i>	
	filter factor		Factor for the switching delay x100 ms	$0x \leq value \leq 60x$	<i>0</i>	
	direction		Defines the effective direction of the switching delay	<i>Up / Down / Both</i>	<i>Down</i>	
4-20 mA	NAMUR Standard	<i>Value input</i>	Activates the behaviour according to NAMUR NE43	<i>activated / deactivated</i>	<i>deactivated</i>	
	<i>Value 4 mA</i>		Measured value for 4 mA output	$MB\ start \leq value \leq Wert\ 20\ mA$	<i>0</i>	
	<i>Value 20 mA</i>		Measured value for 20 mA output	$Value\ 4\ mA \leq value \leq Full\ scale$	<i>Full scale</i>	
0-20 mA	NAMUR Standard		Activates the behaviour according to NAMUR NE43	<i>activated / deactivated</i>	<i>deactivated</i>	
	<i>Value 0 mA</i>		Measured value for 0 mA output	$MB\ start \leq value \leq value\ 20\ mA$	<i>0</i>	
	<i>Value 20 mA</i>		Measured value for 20 mA output	$Value\ for\ 0\ mA \leq value \leq Full\ scale$	<i>Full scale</i>	
2-10 V	NAMUR Standard		Activates the behaviour according to NAMUR NE43	<i>activated / deactivated</i>	<i>deactivated</i>	
	<i>Value 2 V</i>		Measured value for 2 V output	$MB\ start \leq value \leq value\ 10\ V$	<i>0</i>	
	<i>Value 10 V</i>		Measured value for 10 V output	$Value\ for\ 2\ V \leq value \leq Full\ scale$	<i>Full scale</i>	
0-10 V	NAMUR Standard	Activates the behaviour according to NAMUR NE43	<i>activated / deactivated</i>	<i>deactivated</i>		
	<i>Value 0 V</i>	Measured value for 0 V output	$MB\ start \leq value \leq value\ 10\ V$	<i>0</i>		
	<i>Value 10 V</i>	Measured value for 10 V output	$Value\ for\ 0\ V \leq value \leq Full\ scale$	<i>Full scale</i>		

Sub-parameter level 1	Sub-parameter level 2	Sub-parameter level 3	Description	Value range / value list	Standard value LPM version	Standard value GPM version
Frequency output	<i>max. frequency</i>	<i>Value input</i>	Frequency output at "value at max. Hz"	50-1000 Hz	500 Hz	
	<i>overflow</i>		Overflow value in % of the value "max.frequency"	1-100 [%]	1%	
	<i>Value at 0 Hz</i>		Value at 0 Hz	$MB\ start \leq value \leq value\ at\ max.\ Hz$	0	
	<i>Value at max. Hz</i>		Value at "maximum frequency"	$Value\ for\ 0\ Hz < value \leq Full\ scale$	Full scale	
Control input (only output 1)			Control function for MIN / MAX memory reset	OFF, memory reset	Aus	
KofiCom	<i>Factory calibration mode on output 1</i>					
IO-Link	<i>This mode activates the IO-Link function on output 1 (standard factory setting)</i>					

Parameter table Output 1/2 – Volume

Sub-parameter level 1	Sub-parameter level 2	Sub-parameter level 3	Description	Value range / value list	Standard value LPM version	Standard value GPM version
<i>disabled</i>			<i>Output deactivated</i>		<i>disabled</i>	
Pulse output	Pulse unit	<i>List selection</i>	Sets the Pulse Volume for Pulse Volume	<i>ml, L, m3, galUS, galUK, User</i>	<i>L</i>	<i>galUs</i>
	Pulse volume	<i>value input</i>	Sets the value for the pulse volume	0.001-999	1	
	Pulse width		Sets the pulse width	1-20.000	1 ms	
KofiCom	<i>Factory calibration mode on output 1</i>					
IO-Link	<i>This mode activates the IO-Link function on output 1</i>					

Parameter table **Output 1/2 – Temperature**

Sub-parameter level 1	Sub-parameter level 2	Sub-parameter level 3	Description	Value range / value list	Standard value LPM version	Standard value GPM version
<i>disabled</i>			<i>Output deactivated</i>		<i>disabled</i>	
Alarm output	Function	<i>List selection</i>	Sets the basic function	<i>Limit function / window function</i>	<i>Limit function</i>	
	Output		Sets the electr. Output	<i>NPN/PNP/PP</i>	<i>NPN</i>	
	Switching function		Sets the log. switching function	<i>NO/NC</i>	<i>NO</i>	
	Threshold		Sets the switching threshold	$MB\ start \leq value \leq Full\ scale$	<i>1</i>	
	lower threshold		Sets the lower threshold for window function	$Value\ threshold \leq value \leq MB\ start$	<i>1</i>	
	Hysteresis		Defines the switching hysteresis	$0 \leq value \leq (MB\ end - MB\ start)$	<i>1</i>	
	Filter factor		Factor for the switching delay x100 ms	$0x \leq value \leq 60x$	<i>0</i>	
	Direction		Defines the effective direction of the switching delay	<i>Up / Down / Both</i>	<i>Down</i>	
4-20 mA	NAMUR Standard	<i>Value input</i>	Activates the behaviour according to NAMUR NE43	<i>activated / deactivated</i>	<i>deactivated</i>	
	<i>Value 4 mA</i>		Measured value for 4 mA output	$MB\ start \leq value \leq value\ 20\ mA$	<i>0</i>	
	<i>Value 20 mA</i>		Measured value for 20 mA output	$Value\ 4\ mA \leq value \leq Full\ scale$	<i>Full scale</i>	
0-20 mA	NAMUR Standard		Activates the behaviour according to NAMUR NE43	<i>activated / deactivated</i>	<i>deactivated</i>	
	<i>Value 0 mA</i>		Measured value for 0 mA output	$MB\ start \leq value \leq value\ 20\ mA$	<i>0</i>	
	<i>Value 20 mA</i>		Measured value for 20 mA output	$Value\ 0\ mA \leq value \leq Full\ scale$	<i>Full scale</i>	
2-10 V	NAMUR Standard		Activates the behaviour according to NAMUR NE43	<i>activated / deactivated</i>	<i>deactivated</i>	
	<i>Value 2 V</i>		Measured value for 2 V output	$MB\ start \leq value \leq value\ 10\ V$	<i>0</i>	
	<i>Value 10 V</i>		Measured value for 10 V output	$Value\ 2\ V \leq value \leq Full\ scale$	<i>Full scale</i>	
0-10 V	NAMUR Standard	Activates the behaviour according to NAMUR NE43	<i>activated / deactivated</i>	<i>deactivated</i>		
	<i>Value 0 V</i>	Measured value for 0 V output	$MB\ start \leq value \leq value\ 10\ V$	<i>0</i>		
	<i>Value 10 V</i>	Measured value for 10 V output	$Value\ 0\ V \leq value \leq Full\ scale$	<i>Full scale</i>		

Continuation Parameter table **Output 1/2 – Temperature**

Sub-parameter level 1	Sub-parameter level 2	Sub-parameter level 3	Description	Value range / value list	Standard value LPM version	Standard value GPM version
Frequency output	<i>max. frequency</i>	<i>Value input</i>	Frequency output at "value at max. Hz"	<i>50-1000 Hz</i>	<i>500 Hz</i>	
	<i>Overflow</i>		Overflow value in % of the "value at max. frequency"	<i>1-100 [%]</i>	<i>1%</i>	
	<i>Value at 0 Hz</i>		Value at 0 Hz	<i>MB start ≤ value ≤ value for max. Hz</i>	<i>0</i>	
	<i>Value at max. Hz</i>		Value at "max. frequency"	<i>Value for 0 Hz <value ≤ Full scale</i>	<i>Full scale</i>	
Control input (only OUT1)			Control function for MIN / MAX memory reset	<i>OFF, memory reset</i>	<i>OFF</i>	
KofiCom (only OUT1)	<i>Factory calibration mode on output 1</i>					
IO-Link (only OUT1)	<i>This mode activates the IO-Link function on output 1</i>					

Parameter table **Output 1/2 – Part volume**

Sub-parameter level 1	Sub-parameter level 2	Sub-parameter level 3	Description	Value range / value list	Standard value LPM version	Standard value GPM version
<i>Disabled</i>			<i>Output deactivated</i>		<i>disabled</i>	
Pulse output	Pulse unit	<i>List selection</i>	Sets the Pulse Volume for Pulse Volume	<i>ml, L, m3, galUS, galUK, User</i>	<i>L</i>	<i>galUs</i>
	Pulse volume	<i>Value input</i>	Sets the value for the pulse volume	<i>0-999</i>	<i>1</i>	
	Pulse width		Sets the pulse width	<i>1-20.000</i>	<i>1 ms</i>	
Control input (only Out1)			Control function for counter reset	<i>OFF, memory reset</i>	<i>Off</i>	
KofiCom (only OUT1)	<i>Factory calibration mode on output 1</i>					
IO-Link (only OUT1)	<i>This mode activates the IO-Link function on output 1</i>					

5.7 User service

The user service provides the user with a reset function and password setting. Together with the activation of a user password, therefore, the menu access for the user on the part of a master user can be blocked.

5.7.1 User service / change password

In the factory setting the user password is set to "00000", the user functions are thus freely accessible. If the user password is changed to other than "00000", the password prompt becomes active the next time the user menu is entered. If the set password is no longer known, a master password can be requested from KOBOLD.

5.7.2 User service / factory setting

By activating this function, the user can reset the device to the factory settings. Any user settings will then be lost and the device will be back in delivery condition.

Parameter table **User menu**

Sublevel	Parameter level	Description	Value range / value list	Standard value LPM version	Standard value GPM version
Password	value input	Protects the user service menu by password prompting if the password is not "00000"	<i>00000-99999</i>	<i>00000</i>	
Factory reset	Yes / No	Resets the device to factory settings			
Menu lock	unlocked / closed	<i>With "locked", the menu access only takes place via the password prompt</i>	unlocked / closed	<i>unlocked</i>	
Sim Autostop	Value input	<i>Sets the time for how long the simulation mode remains active</i>	<i>1 - 31 min.</i>	<i>10 min.</i>	

5.8 Service / Factory service

The factory service function is password protected and not accessible to the user.

5.9 Info

5.9.1 General

This info option displays the measuring ranges of the device for flow and temperature.

5.9.2 Version

This info option displays the hardware and software version of the device.

Parameter table **Info**

Menu level	Sublevel	Description
Info	General	Displays the measuring ranges of the device
	Version	Displays the hardware and software version
	Manual	Displays the QR code to download the instruction manual

5.10 Device default settings

The measurement device is factory set and unloaded with the following configuration:

Display - Dual

Upper display - Flow

Lower display - Temperature

Out 1: **IOLINK**

Out 2: **OFF**

IOLINK	Off
0.000	+Q L/m
25.60	+T °C
	Status

6. Dosing function

The standard electronic C3T0 provides a simple dosing function. This can be permanently activated or deactivated in the settings menu under the menu item "dosing". If the dosing function is activated, fixed functions are assigned to the 2 outputs which cannot be changed as long as the dosing function is activated:

OUT2 (Pin 2): Dosing output in push pull configuration
 OUT1 (Pin 4): Control input for START/STOP/RESET function



Attention!

When the control input is used, then OUT1 (connection pin 4) must be always polarised, either to the 24 Vdc or to the GND (pin 3). When using a mechanical button that switches the supply voltage to the control input, a 10 kOhm pull-down resistor is recommended. The control input must not be left open!

If the dosing function is deactivated, both outputs are switched to OFF (deactivated) by default, but can then be freely configured again.

Dosing Edit Menu

Main Display Dosing

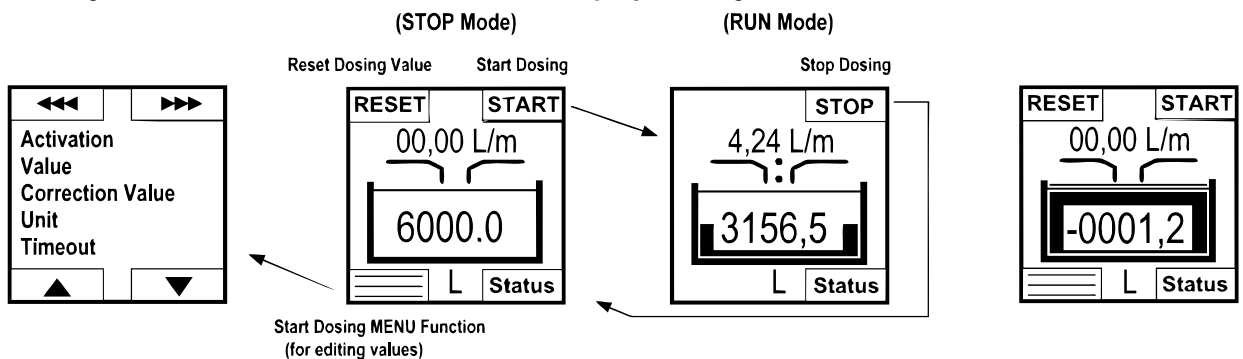

In the main display of the dosing function, the quantity to be dosed in a preselectable unit and the current flow value are displayed on the one hand. The progress of the dosing process is additionally represented by a graphic animation in which the container shown fills in percent and also overflow is shown.

Softkey buttons: All softkey buttons in dosing mode must be held down by the user for at least 2 seconds and then released again for the corresponding function to be triggered. This is to avoid accidental operation.

Control input: Connection OUT1 can be used as a control input for the functions Start / Stop / Reset when the dosing function is activated.

Function	Conditions	Control pulsetime
START	Stop Modus	$0.5\text{ s} < t_{\text{high}} < 4\text{ s}$
STOP	Run Modus	$0.5\text{ s} < t_{\text{high}} < 4\text{ s}$
RESET	Stop Modus	$t_{\text{high}} > 5\text{ s}$

START of dosing:

Dosing can be started either by triggering the "START" softkey or by applying a high pulse to the control input.

After the START function has been triggered, the dosing output is switched to active (High) and the dosing counter is counted down in the standard direction when flow is present.

If the dosing process is stopped incompletely by hand, it can be restarted by the START function.

STOP of dosing

If the dosing process is started, it can be stopped or interrupted by the STOP function. Resumption of dosing to reach the total dosing quantity is possible by START.

Like the START function, the STOP function can be remotely controlled by the control input.

RESETTING the dosing value

If the dosing process is finished or stopped, the dosing quantity can be reset to the default value by the function RESET.

This function can also be triggered at the control input.

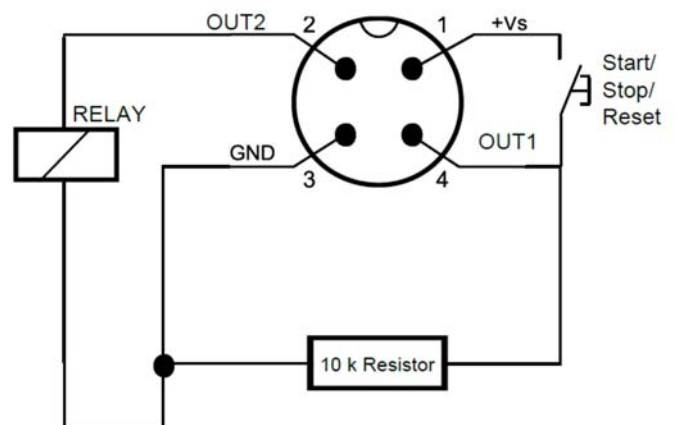
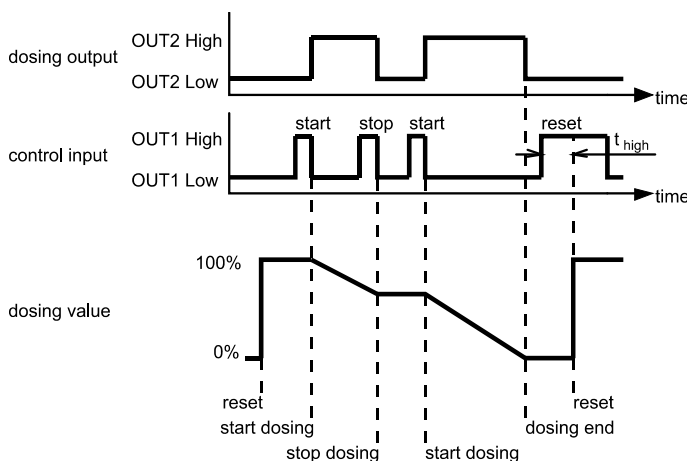

Description of dosing parameters

Dosing quantity "Value"

Parameter "Value" determines the dosing volume. The volume unit is specified in the "Unit" parameter.

The maximum size is limited to 9999.9 (one digit after the decimal point). The absolute quantity can be extended or restricted by a suitable choice of dosing unit.

Dosing unit "Unit"

Parameter "Unit" defines the dosing volume unit. The choices are: mL, L, m3, galUS, galUK, barrel, user

Dosing correction value "Correction value"

The "Correction value" parameter can be used to correct a system-related, constant "incorrect dosing" without having to change the actual dosing quantity. The correction value can be both positive and negative. If the system doses a smaller volume than intended, the correction value must be positive, but negative for a larger real volume. e.g.

Dosing quantity = 10 L

Correction value = -1 L

In this case, the metering counter will count from 10 L to '0', but will stop at 1 L because the quantity to be metered is 9 L calculated on the basis of the correction value of -1 L.

With a correction value of +1 L, the dosing counter will stop counting at -1 L, because the dosing amount is calculated to be 11 L.

$10 - (-1 \text{ L}) = 11 \text{ L}$

The adjustable value of the correction value must always be:

(Value + Correction Value) > 0

If this condition is not met, this will be indicated by a warning message and the correction value will be preset to the value - (Value-0.1).

Dosing parameter "Timeout"

During the dosing process, the presence of a flow value not equal to 0 is constantly monitored. For this purpose, the parameter "Timeout" is used to set the time after which the status message "Time Out" is triggered.

The timeout value can be set between 0.5 sec and 10 sec.

Parameter table **Dosing**

Sublevel	Parameter level	Subparameter level 1	Subparameter level 2	Subparameter level 3	Description	Value range / value list	Standard value LPM version	Standard value GPM version
Activation	disabled				Dosing function deactivated		<i>disabled</i>	
	activated	Activation			Dosing function activated			
		Value	Value input			$0 \leq \text{Value} \leq 9999.99$ [unit]	0	
		Correction value	Value input			$-999.99 \leq \text{Value} \leq +999.99$ [unit]	0	
		Unit	List selection			ml, L, m3, galUS, galUK, User	L	galUS
		Time out	Value input			0.5 - 10 sec	0.5 sec.	

7. Disposal

Note!

- Avoid environmental damage caused by media-contaminated parts
- Dispose of the device and packaging in an environmentally friendly manner
- Comply with applicable national and international disposal regulations and environmental regulations.

Batteries

Batteries containing pollutants are marked with a sign consisting of a crossed-out garbage can and the chemical symbol (Cd, Hg, Li or Pb) of the heavy metal that is decisive for the classification as containing pollutants:

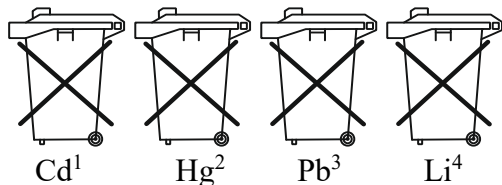

1. „Cd" stands for cadmium
2. „Hg" stands for mercury
3. „Pb" stands for lead
4. „Li" stands for lithium

Electrical and electronic equipment

